

Side bending LED Flex Neon light

S0612-S
S1220-S

S1020-S
S1225-S

Glowing softly, can be bent perpendicular to the light-emitting surface.
Suitable for decorative lighting, as well as outlining patterns and contours,
adding atmosphere and beauty.

Such as: outdoor art words, entertainment venues, exhibition venues.



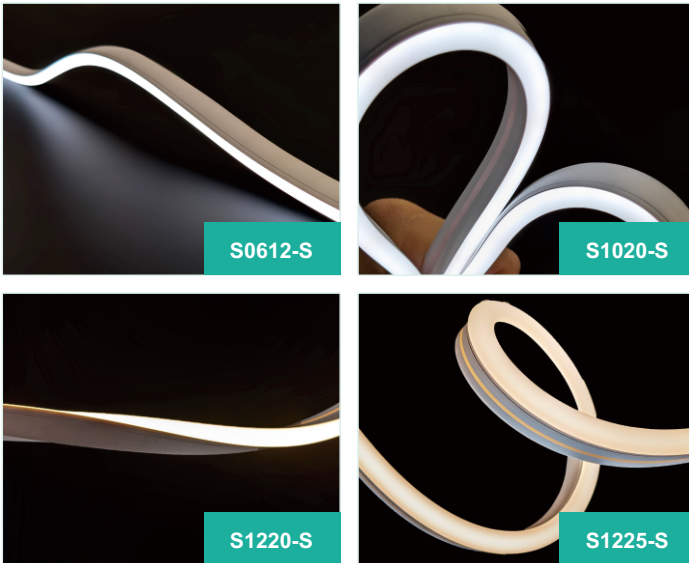

Silicone

High-quality silicone material, high light transmittance, anti-UV & anti-corrosion.



IP67

Full silicone encapsulation technology, LED&PCB fully sealed, no any water immersion risk.



Dotless

Uniform light emission, no dark areas.

BENDING DIAGRAM

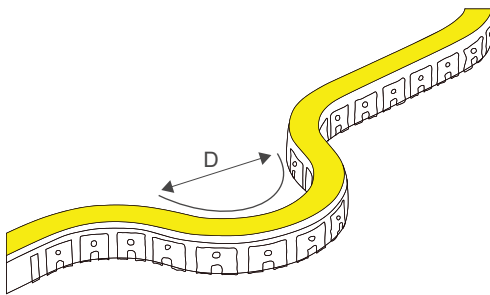

S0612-S: $D \geq 80\text{mm}$
 S1020-S / S1220-S / S1225-S: $D \geq 100\text{mm}$

VARIOUS CABLE ENTRY

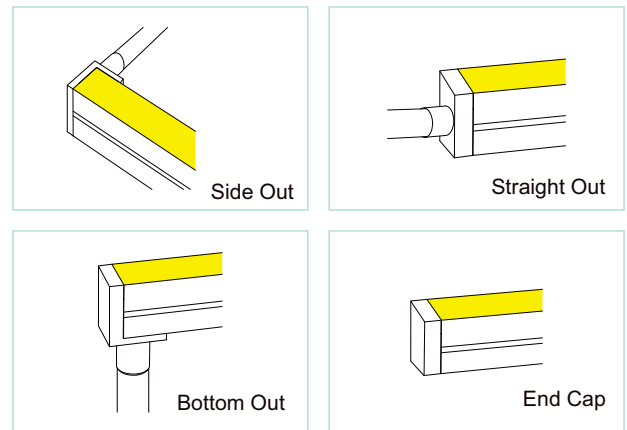

PRODUCT PARAMETERS

Model	S0612-S	S1020-S	S1220-S	S1225-S
Input	DC24V			
LED/M	126pcs/M			
M/Reel	5M/Reel	10M/Reel	10M/Reel	10M/Reel
LED type	SMD			
CRI	>90			
IP rating	IP67			
Power	8.6W/M	13W/M	13W/M	13W/M
Lumen/M	258 lm/M@3000K	390 lm/M@3000K	390 lm/M@3000K	455 lm/M@3000K
CCT	2700K 3000K 4000K 6500K R G B			



COMPATIBILITY

ON/OFF

Triac

0/1-10V

DALI

PWM







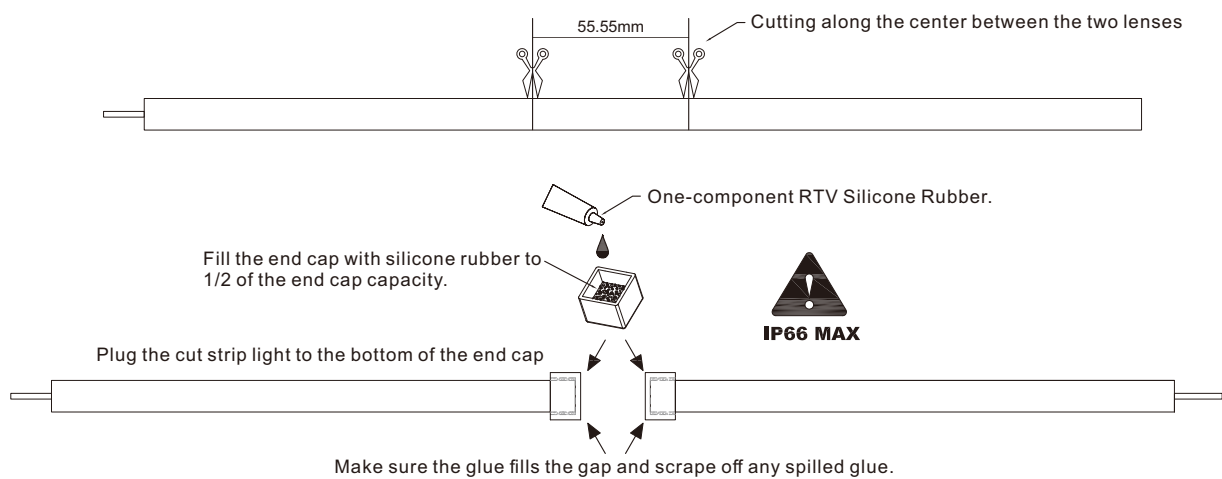





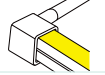







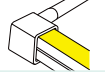





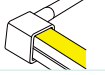
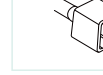
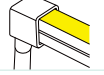
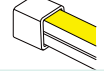

★ Please conduct a match test between the strip light and dimmable controllers if dimmable control method required to avoid any performance failure, as the strip light contains the constant current IC, differing from normal constant voltage strip light.

CUTTING AND SEALING

Attention: After cutting and bonding, the waterproofing will decrease and cannot be used underwater anymore!
Please refer to the following method to bond the end cap, and the maximum waterproofing can reach IP66.

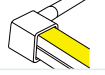

INSTALLATION ACCESSORIES

Category	Model	Description	Picture
S0612-S	Aluminum Profile	AL6063 Size:7.9x13.6x2000mm	
	3D Flexible Profile	SUS304 Size:7.2x12mm	
	Clip	AL6063 Size:7.9x13.6mm	
	Input cap	  End cap	
	Wire Size:4x200mm	 Glue	
S1020-S	Aluminum Profile	AL6063 Size:12.4x14x2000mm	
	3D Flexible Profile	SUS304 Size:11x13.1mm	
	Clip	AL6063 Size:12.4x14mm	
	Input cap	  End cap	
	Wire Size:6x200mm	 Glue	
S1220-S	Aluminum Profile	AL6063 Size:14.3x19x2000mm	
	3D Flexible Profile	SUS304 Size:13.4x18mm	
	Clip	AL6063 Size:14.3x19mm	
	Input cap	   End cap	
	Wire Size:6x200mm	 Glue	
S1225-S	Aluminum Profile	AL6063 Size:14.3x19x2000mm	
	3D Flexible Profile	SUS304 Size:13.4x18mm	
	Clip	AL6063 Size:14.3x19mm	
	Input cap	  End cap	
	Wire Size:6x200mm	 Glue	